



The computer control of MALDI system

Marcin Smolira*, Jan Cytawa, Leszek Michalak

*Institute of Physics, Maria Curie-Skłodowska University,
Pl. Marii Curie-Skłodowskiej 1, 20-031 Lublin, Poland*

Abstract

The computer program controlling MALDI system and a time of flight mass spectrometer is described. This program allows to reduce a number of necessary activities for operation of used machines as well as to raise an operational safety of this equipment. Additionally, an advantage of the computer control is possibility of quick changing of any measurement parameters that is impossible to do manually.

1. Introduction

MALDI (*Matrix Assisted Laser Desorption and Ionization*) is a quite new method used in the mass spectrometry since the middle of eighties for the analysis of biomolecules [1-3]. This method uses a solid matrix and the pulsed laser light. Ions are formed as a result of directing a pulsed laser beam onto a sample holder with a sample dissolved in a matrix. The matrix – usually an aromatic acid - absorbs the laser light energy and causes desorption and ionization of sample molecules. Ions created in such a way are directed into the mass analyzer, usually the Time Of Flight Mass Spectrometer (TOF MS).

Idea of the TOF MS spectrometer is given in Fig. 1 [4]. The ion system consists of the stainless steel sample holder, two pairs of deflecting electrodes (horizontal and vertical), the reflectron and the detector. The sample–matrix mixture placed on the sample holder is lighted by the focused ($f = 15$ cm), pulsed beam of the nitrogen laser LN300C (Laser Photonics, $\lambda=337$ nm, the width of a pulse is 3ns and the maximal power of 50 kW).

The generated ions are accelerated in the electric field between the sample holder and the grounded flat electrode. The accelerated ion beam flights between the horizontal and vertical deflecting electrodes for correction of its trajectory. Then the ion beam flights through the field free region and the reflectron to the detector. The ions separation proceeds with regard to their velocity. Ions with

* Corresponding author: *e-mail address*: mamolira@tytan.umcs.lublin.pl

the higher mass (m) to charge (z) ratio achieve lower velocities and their time of flight from ion source to the detector is adequately longer. Thus the ion packet created in the ion source as a mixture of different ions is separated to series of packets, and depends on the m/z ratio. The ion packet enter the reflectron with the spread of their kinetic energies. The ions with higher energy (higher velocity) penetrate the reflectron deeper than ions with lower energy. It means that faster ions spend adequately longer time in the reflectron area. Finally, all ions with the same m/z ratio reached the detector at the same time. In our spectrometer a two-stage micro channel plate detector F4655-10 (Hamamatsu) is used. The signal from the detector is directed to an oscilloscope (Hewlett Packard Oscilloscope, HP54154B, 500MHz, 1Gsa/s). The oscilloscope is triggered by the signal from the nitrogen laser. For the supply of the spectrometer several electric feeders (Knür-Heinzinger) are used (Fig. 1). The accelerating voltage is applied from PNC20000-3ump feeder. Two feeders (LNG350-06) are used for the deflecting voltage. The MPC detector is fed from PNC3500-20ump feeder.

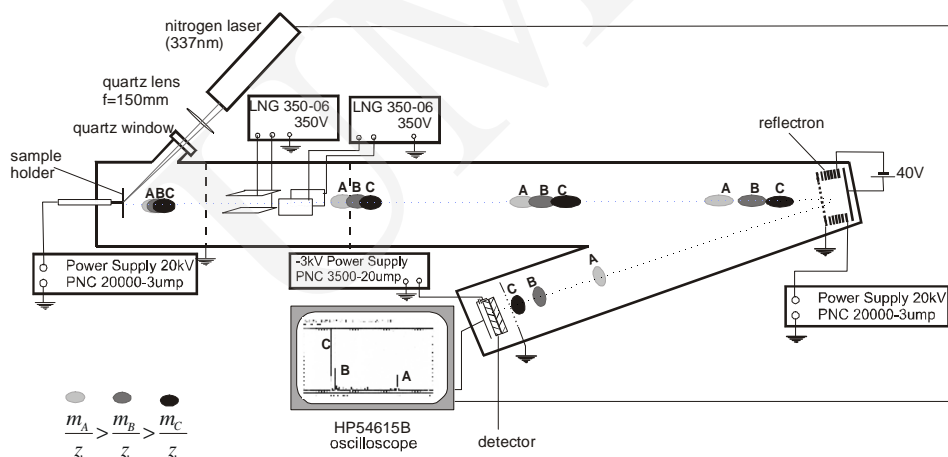

Fig. 1. An electrical TOF MS scheme and idea of ions formation and separation in this spectrometer

The TOF mass spectrometer (Fig. 2) consists of two vacuum chambers i.e. ion source and analyser chambers. Each of vacuum chamber system consists of the BL30P rotary pump for a initial vacuum, connected by the oil trap and the valve ZWK25 with the turbomolecular pump (ETP300 for the ion source chamber and ETP450 for the analyser chamber). All flexible vacuum connections are made by using the PVC25 tube. Both chambers are separated by the gate vacuum valve E-GV-6000V (MDC Vacuum Products Corporation). Application of this valve ensures high vacuum in the detector region while the sample in the ion source is changed. The described vacuum system allows to

obtain an initial vacuum (0.133 Pa) during 10 minutes and high vacuum ($0.133 \cdot 10^{-4}$ Pa) during the next 10 minutes.

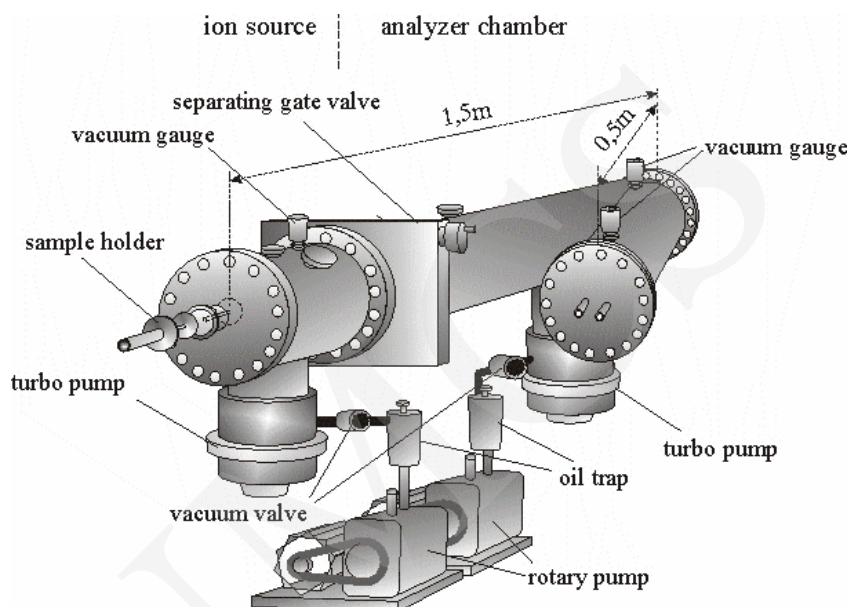

Fig. 2. The vacuum system of the TOF spectrometer

2. Hardware

To operate MALDI system and the time of flight mass spectrometer an analog-digital ISA card (ADC615, Institute of Mathematical Machines in Warsaw), (Fig. 3) was used.



Fig. 3. The analog-digital card ADC615

This card is provided with:

- 16 digital inputs;
- 16 digital outputs;
- 16 analog inputs;
- 2 analog outputs.

The logic of digital signals is consistent with TTL standard. It means that logical '1' conforms to 0 V voltage (not more than 0.8 V) and logical '0' corresponds to 5 V voltage (not less than 2.6 V). Analog inputs and outputs work in a range from 0 V to 10 V. The card is connected with the spectrometer through an external interface. It lets connect all the equipment with proper outputs and inputs of the ADC615 card. The application of relays enables to introduce all needed equipment protection. A schematic diagram of mass spectrometer – card connections is shown in Fig. 4.

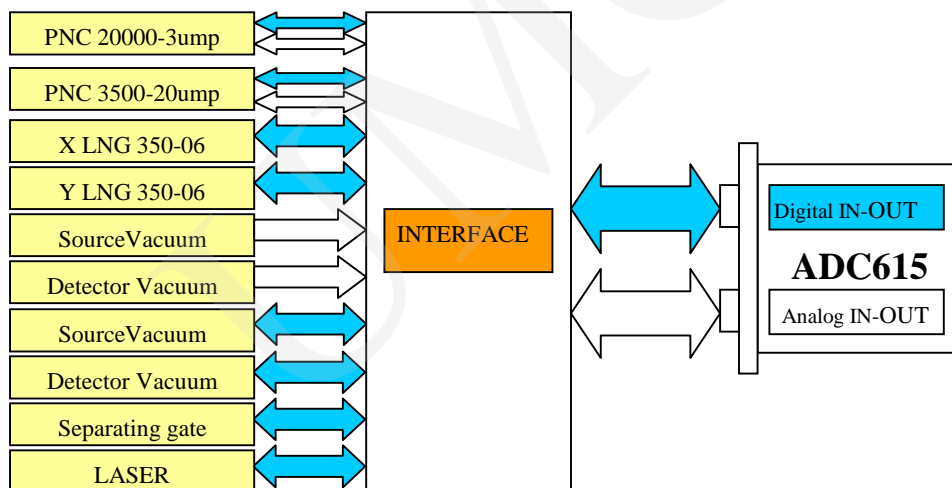

Fig. 4. A schematic diagram of spectrometer – card connections

3. Software

The ADC615 card is provided with the operating system DOS drivers and a source code written in a C++ language. Additionally, it has an instruction with a description of address ports that the card uses. For practical reasons a computer program for this card was decided to be written for the operating system Windows.

The ADC615 card uses address ports from 300H to 315H. The operating system Windows does not allow for access to these ports directly so we can't use DOS instructions write and read from port like "outport" or "inport". For this reason a card driver must have been made first. The DDK Microsoft

documentation was used to write it [5]. The computer program and the card driver were written using Delphi software.

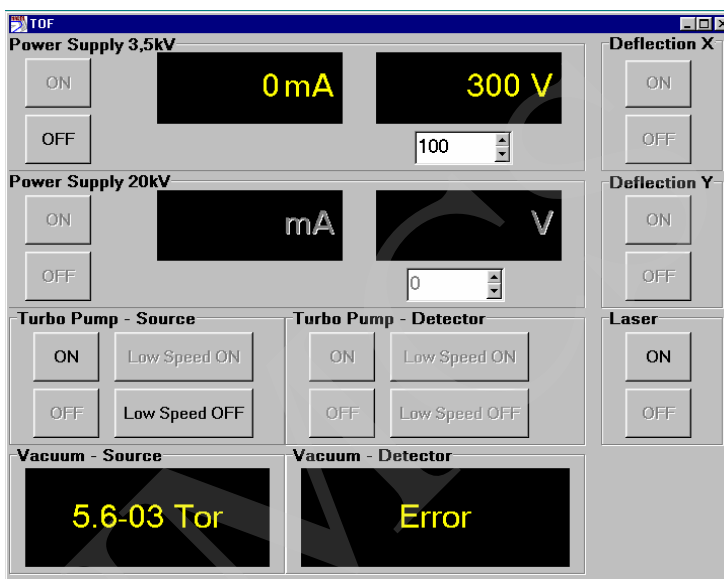

Fig. 5. The main window of the computer program

The computer program (Fig. 5) allows to operate:

- power supplies (see Fig. 4),
- nitrogen laser (see Fig. 4),
- turbo pump controllers,

and to control critical points of the spectrometer such as:

- readout from vacuum meters,
- turbo pumps water cooling,
- vacuum valves state (OPEN/CLOSE),
- separating gate valve state (OPEN/CLOSE).

Owing to the above readouts a risk of a damage of any equipment of the mass spectrometer is reduced. Some of these protections are:

- auto-stop of turbo pumps when there is no water cooling,
- auto-stop of turbo pumps when the pressure in the mass spectrometer is too high (>0.133 Pa),
- impossibility of turning turbo pumps 'on' when the pressure in the mass spectrometer is too high (>0.133 Pa),
- impossibility of turning the laser 'on' when gate valve is closed,
- impossibility of the separating gate valve opening when the pressure difference between the ion source and the analyzer chamber is too high (13,3 Pa),

- impossibility of exceeding of power supplies safe voltage.

The above examples show that the computer program dictates a safe way of using the spectrometer and informs a user about things that should be done at any moment (Fig. 6).

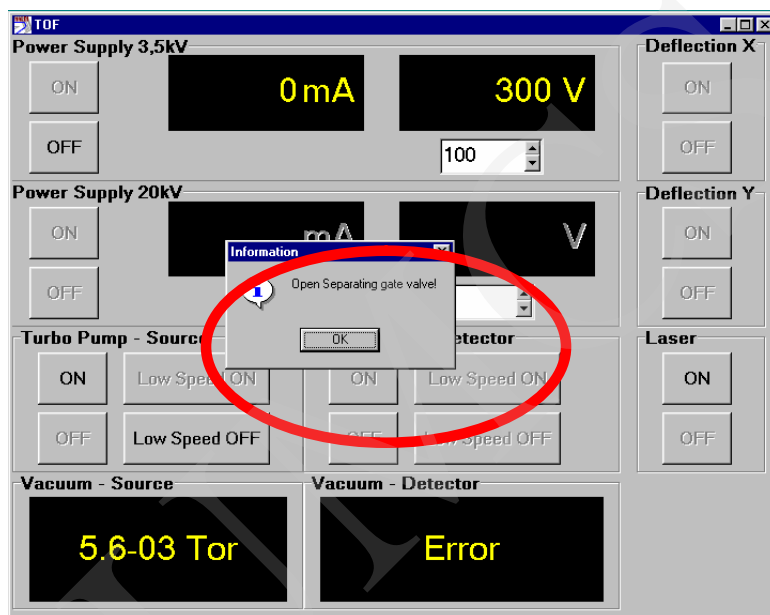

Fig. 6. The window information for a user

Conclusions

Thanks to use of the computer program operating MALDI system and the TOF mass spectrometer a user can reduce a number of activities connected with operation of this equipment. A risk of an equipment damage, because of some sudden events such as lack of water, is reduced. The computer program will also not allow for activities not consistent with a proper operation of the TOF mass spectrometer.

An additional advantage of the computer operating is possibility of quick changing of any parameters that is impossible to do manually, for example the increasing of a voltage in five milliseconds after turning the laser on.

References

- [1] Bajuk A., Gluch K., Michalak L., Rapid Commun. Mass Spectrom., 15 (2001) 2383.
- [2] Bajuk A., Michalak L., Rapid Commun. Mass Spectrom., 16 (2002) 951.
- [3] Ptasińska S., Michalak L., Smolira M., Rapid Commun. Mass Spectrom., (in press).
- [4] Gluch K., Bajuk A., Michalak L., Maintenance and Reliability, 2-3 (2001) 54.
- [5] Finnegan J., *Pop Open a Privileged Set of APIs with Windows NT Kernel Mode Drivers*, MSJ, March (1998); <http://www.microsoft.com/msj/0398/driver.htm>